



Phone for your nearest
ULLRICH ALUMINIUM SALES CENTRE

AUSTRALIA - 1300 650 075

NEW ZEALAND - 0800 500 338

- ALUMINIUM EXTRUSIONS
- ROLLED PRODUCTS
- FASTENINGS
- LADDERS
- SCAFFOLDS
- ULLTRACLAD CLADDING
- WINTEC WINDOWS & DOORS
- BUILDING PRODUCTS
- DECORATIVE METALS
- TEKNA MACHINERY

Representative and franchised operations throughout the South Pacific

ULLRICH ALUMINIUM PTY LTD
 PO Box 2182 Smithfield NSW 2164
 185-187 Woodpark Rd Smithfield Australia
 Tel +61 2 8787 7400 Fax +61 2 9725 2784
 ullrich@ullrich.com.au www.ullrich.com.au

ULLRICH ALUMINIUM CO LTD
 PO Box 98 843 SAMC
 Manukau City 2240 New Zealand
 Tel +64 9 262 6262 Fax +64 9 262 6265
 alkalum@uacl.co.nz www.ullrich.co.nz



*The Aluminium
 Garage Door Liner*

ALI-JAMB



ALI-JAMB

The Aluminium Garage Door Liner

THE ONLY PURPOSE BUILT GARAGE DOOR LINER MADE FROM POWDER COATED ALUMINIUM TO SUIT ALL TYPES OF STANDARD CLADDING AND GARAGE DOORS SUPPLIED IN EASY TO INSTALL KITSET FORM.

Built-in architrave with Gib groove fitted with mohair seal for water proofing.



Clean, strong, straight line for cladding.
Mitred corner joints.

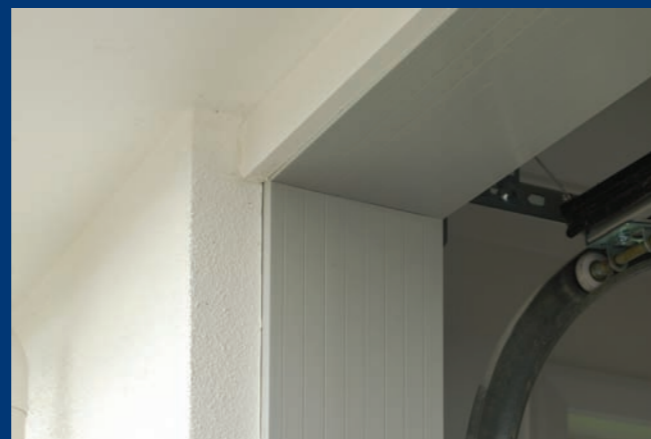

FEATURES

- Manufactured from 2mm thick aluminium for strength
- Powder coated to your required colour
- Fastened with unique clip system for easy replacement in case of damage
- Up to 30mm adjustment for framing discrepancies

INSTALLATION INSTRUCTIONS

MEASURE FROM CONCRETE TO UNDERSIDE OF LINTEL. SUBTRACT 20mm. CUT LEGS TO LENGTH

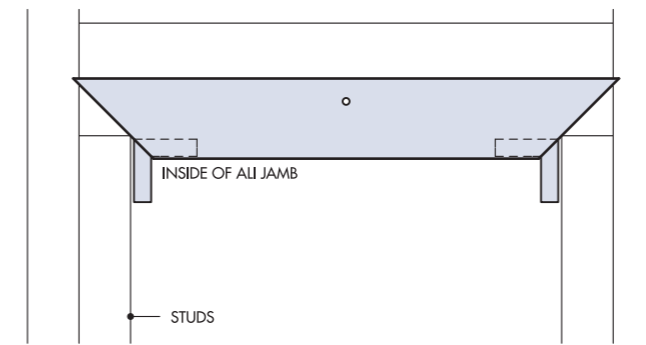

1 POSITION HEAD PROFILE
HOLD HEAD PROFILE UP TO LINTEL AND INSTALL CENTRAL FACE SCREW

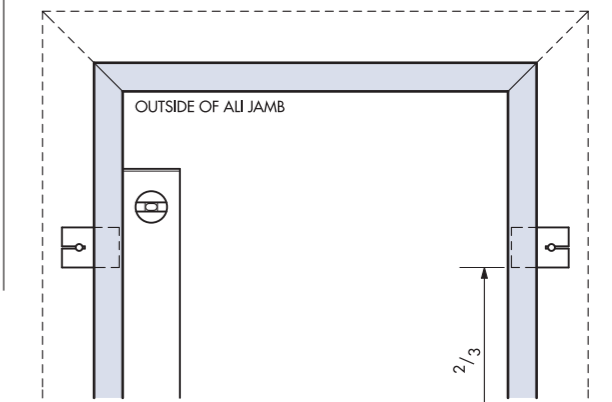

4 INSTALL JAMB CLIPS
CHECK FOR PLUMB OUTSIDE EDGE WITH LEVEL AND INSTALL 2 TO 3 CLIPS UP EACH SIDE. NO HIGHER THAN TWO THIRDS UP SIDES. REFER DETAIL 6 FOR CLIP INSTALLATION POSITION

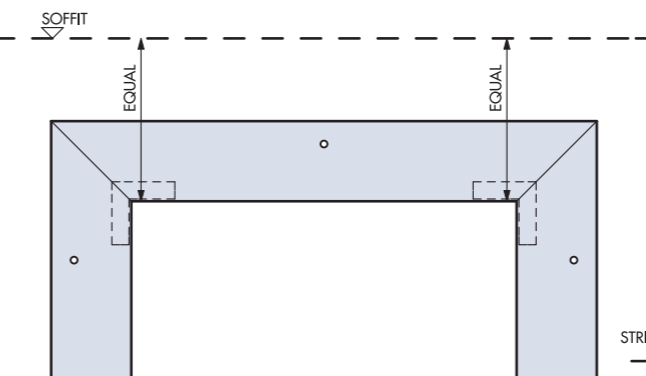

2 FIX SIDE PROFILES
SLIDE SIDE PROFILES OVER CORNER CLEATS. LEVEL EACH SIDE WITH SOFFIT PLUMB AND INSTALL FACE SCREWS TO SIDE PROFILES

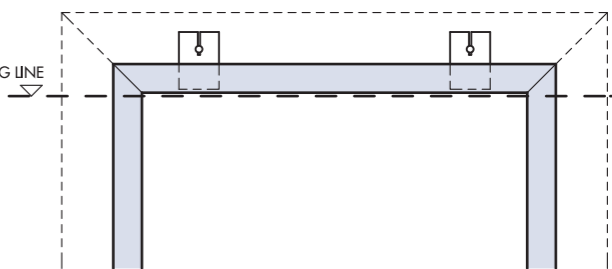

5 INSTALL HEAD CLIPS
RUN STRING LINE ALONG AND ACROSS UNDERSIDE OF HEAD PROFILE. INSTALL HEAD CLIPS

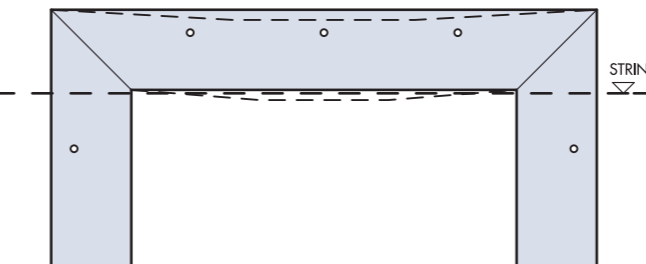

3 PLUMB HEAD PROFILE
REMOVE CENTRAL SCREW AND ALLOW HEAD PROFILE TO SAG. LEVEL HEAD PROFILE TO STRING LINE AND INSTALL FACE SCREWS TO HEAD

BUILDING WRAP DRESSED INTO OPENING AND RETURNED UNDER ALI JAMB FINIS. WITH FLASHING TAPE ETC. AS REQUIRED

MELTHOID FLASHING BY OTHERS

BRICK VENEER SHOWN, OTHER CLADDINGS SIMILAR

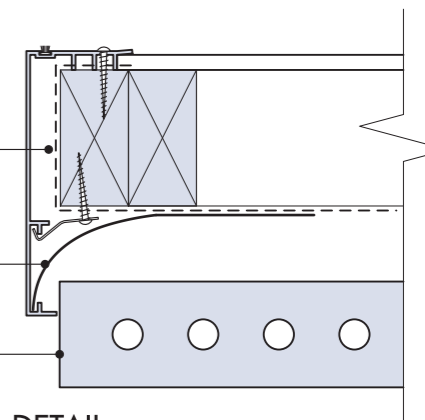

6 ALI JAMB, JAMB DETAIL
SCALE 1:5

ALI-JAMB
The Aluminium Garage Door Liner